

Article number: 201134104

Description: E+G Guide bush DIN 172-B22-36-A
with collar

Measures

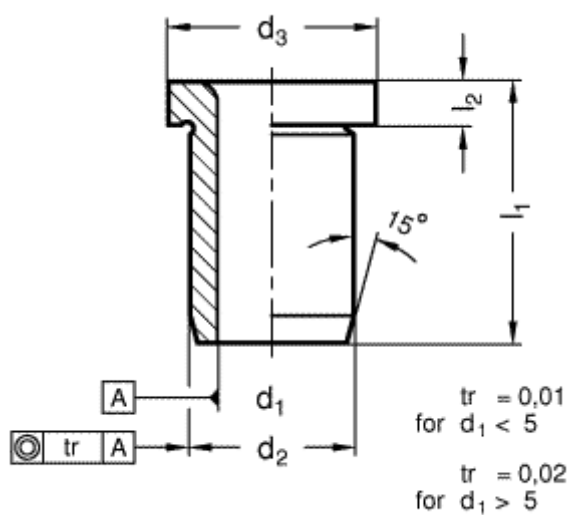

d1 = 24

d2 = 35

d3 = 39

l1 = 36

l2 = 5